

styling

Clic Clac

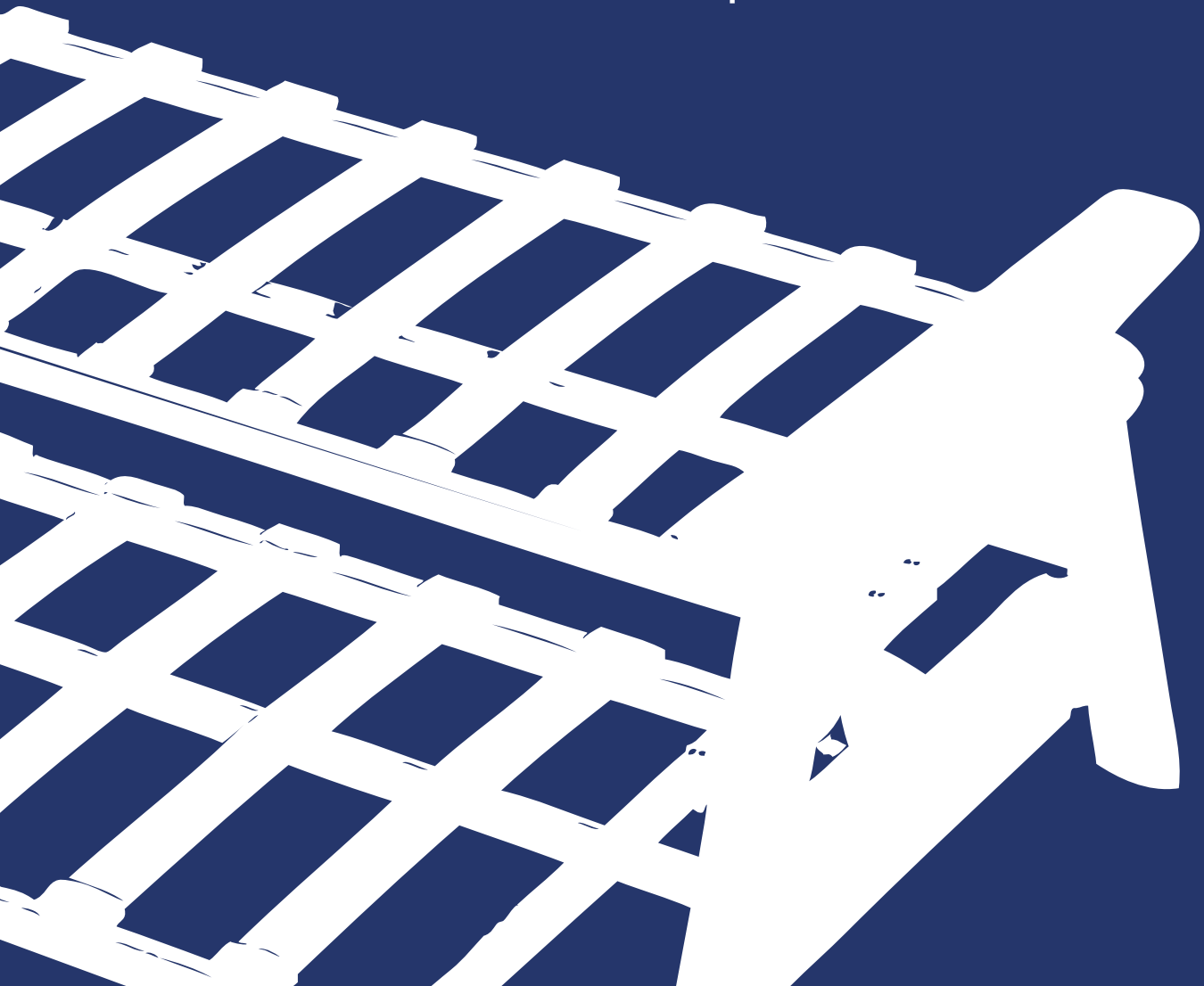

english

Mechanism equipped with a three movement opening system. The front-side lifting system allows the use of the compartment under the seat.

It is realized with highly-resistant cold-rolled steel tube of top quality and is lacquered with epoxy resins in high temperature oven. The inclined seat and backrest guarantee greater comfort.

STICK 1

Sleeping area is made up of 60mm-slats.

SLIDER

Sleeping area is made up of 53mm-slats.

ECLIPSE

Sleeping area is made up of 53mm-slats.

BRIDGE

Sleeping area is made up of 53mm-slats.

CC E74

Sleeping area is made up of 53mm-slats.

CC 999

Sleeping area is made up of 53mm-slats.

CC R80

Sleeping area is made up of 53mm-slats.

español

Mecanismo cama lista en tres posiciones; la apertura con la alzada delantera consiente la realización de un contenedor bajo el asiento.

Está realizado en tubos de acero formados en frío de calidad a alta resistencia; y barnizados en polvo al horno a alta temperatura.

El asiento y el respaldo están inclinados para una mayor comodidad de utilización. El somier está formado por láminas en multicapas de haya.

STICK 1 - El somier está formado por láminas de 60 mm.

SLIDER - El somier está formado por láminas de 53 mm.

ECLIPSE - El somier está formado por láminas de 53 mm.

BRIDGE - El somier está formado por láminas de 53 mm.

CC E74 - El somier está formado por láminas de 53 mm.

CC 999 - El somier está formado por láminas de 53 mm.

CC R80 - El somier está formado por láminas de 53 mm.

italiano

Meccanismo pronto letto a tre posizioni; l'apertura con sollevamento anteriore consente la realizzazione di un contenitore sotto la seduta.

E' realizzato in tubi d'acciaio formati a freddo di qualità ad alta resistenza; è verniciato a polvere in forno ad alta temperatura.

La seduta e la spalliera sono inclinate per un maggior comfort di utilizzo.

Il piano dormita è formato da doghe in multistrato di faggio.

STICK 1

Il piano dormita è formato da doghe da 60 mm.

SLIDER

Il piano dormita è formato da doghe da 53 mm.

ECLIPSE

Il piano dormita è formato da doghe da 53 mm.

BRIDGE

Il piano dormita è formato da doghe da 53 mm.

CC E74

Il piano dormita è formato da doghe da 53 mm.

CC 999

Il piano dormita è formato da doghe da 53 mm.

CC R80

Il piano dormita è formato da doghe da 53 mm.

français

Ce modèle est caractérisé par un mécanisme d'ouverture à glissière antérieure à trois positions et par un coffre de rangement.

Il est réalisé avec des tubes en acier forgés à froid à haute résistance de bonne qualité. Vernissage à la poudre époxyde noire cuite au four à haute température.

Le siège et le dossier penchés raffermissent votre confort.

STICK 1

Le plans de couchage est pourvu de lattes de 60 mm.

SLIDER

Le plans de couchage est pourvu de lattes de 53 mm.

ECLIPSE

Le plans de couchage est pourvu de lattes de 53 mm.

BRIDGE

Le plans de couchage est pourvu de lattes de 53 mm.

CC E74

Le plans de couchage est pourvu de lattes de 53 mm.

CC 999

Le plans de couchage est pourvu de lattes de 53 mm.

CC R80

Le plans de couchage est pourvu de lattes de 53 mm.

deutsch

Bettsofamechanik mit drei Stellungen. Bei der Öffnung durch Ausklappen nach vorne kommt unter der Sitzfläche ein Kasten aus hochwertigen kaltgeformten widerstandsfähigen Stahlröhren, bei hoher Temperatur mit Pulver ofenlackiert, zum Vorschein. Die Sitzfläche und die Rückenlehne sind für mehr Komfort etwas schräggestellt.

STICK 1 - In dieser Ausführung besteht die Liegefläche aus elf: 60mm-breite Latten.

SLIDER - In dieser Ausführung besteht die Liegefläche aus elf: 53mm-breite Latten.

ECLIPSE - In dieser Ausführung besteht die Liegefläche aus elf: 53mm-breite Latten.

BRIDGE - In dieser Ausführung besteht die Liegefläche aus elf: 53mm-breite Latten.

CC E74 - In dieser Ausführung besteht die Liegefläche aus elf: 53mm-breite Latten.

CC 999 - In dieser Ausführung besteht die Liegefläche aus elf: 53mm-breite Latten.

CC R80 - In dieser Ausführung besteht die Liegefläche aus elf: 53mm-breite Latten.



styling

Clic Clac

STICK 1



styling

Clic Clac

SLIDER



styling

Clic Clac

CC E74



Particolare fiancata.
Detail of the side.
Détail du côté.
Detail der Seitenblende.
Detalle del costado.

styling

Clic Clac

CC 999



CC 999



CC 999/03

Doppi tubi Reggi Amaca - Double hammock holding tubes.
Double tubes porte-hamac - Röhrenförmiges Gestell für Hängematte.
Tubos dobles sujeta hamaca.



CC 999/01



styling

Clic Clac

CC R80



Particolare fiancata.
Detail of the side.
Détail du côté.
Detail der Seitenblende.
Detalle del costado.

styling

Clic Clac

BRIDGE



Particolare dei piedi.
I piedi posteriori sono snodabili.

Detail of the feet.
Rotating back feet.

Détail des pieds.
Les pieds postérieurs sont tournants.

Detail der Füßchen.
Die hinteren Füßchen sind drehbar.

Detalle de los pies.
Los pies posteriores son articulares.



styling

Clic Clac

ECLIPSE



ECLIPSE 01



ECLIPSE 01



ECLIPSE 03



ECLIPSE 04



ECLIPSE 05

Copertura in legno non fornita.
Wood covering is not available.
La couverture en bois n'est pas disponible.

Keine Holzverkleidung erhältlich.
La cobertura en madera no se suministra.

styling

Clic Clac

ECLIPSE

ECLIPSE 03



ECLIPSE 04



ECLIPSE 05



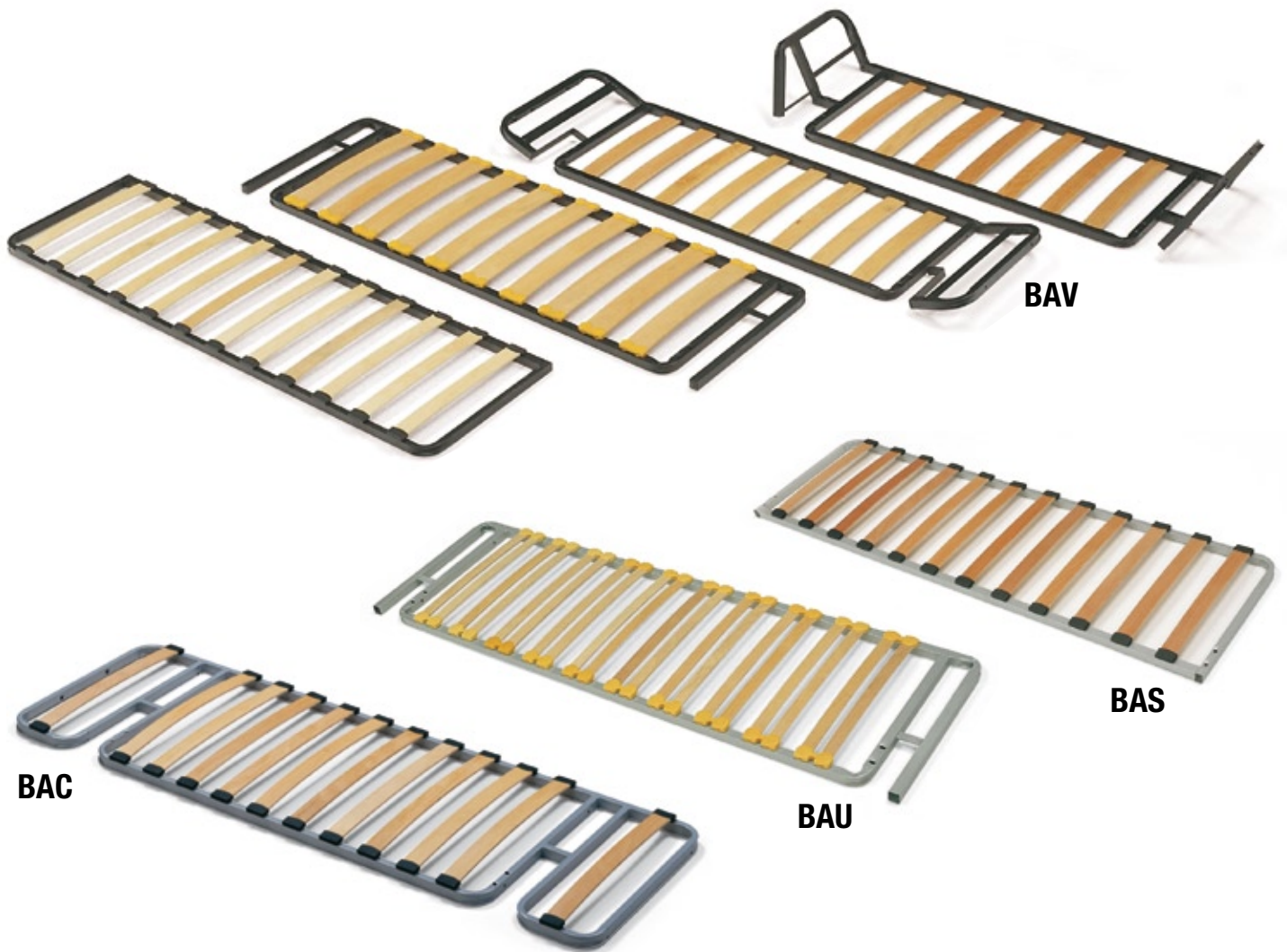

BAS	Tubo 30x20 nero/grigio	BAC	Tubo 30x20 nero/grigio	BAU	Tubo 30x20 nero/grigio
Larg. B	Lung. A	Doghe 53/2x38/83	Larg. B	Lung. A	Doghe 53/2x38/83
55	184	12S	57	190	12S
60	184	12S	62	190	12S
65	184	12S			
			BAV	Tubo 30x20 nero/grigio	
			Larg. B	Lung. A	Doghe 53/2x38/83
			57	182	8S
					Tubo 30x30 nero/grigio
					57
					189
					10S
					189
					10S
					Tubo 30x30 nero/grigio (Doghe 68)
					57
					189
					10 I
					62
					189
					10 I

S= Sovrapposte
I= Incassate

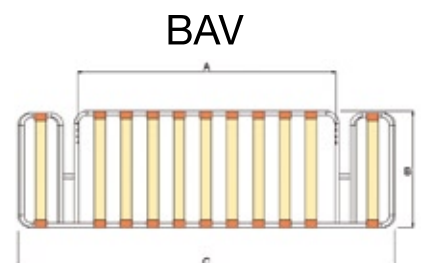
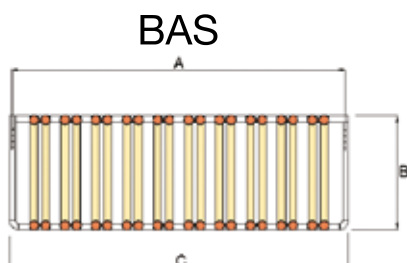
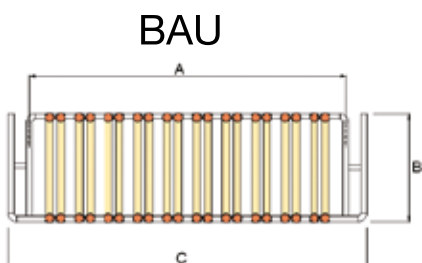

BRACCIOLO MOD. A0 30X30

Anche per modelli Siedi e Dormi.

Disponibile versione con forchetta d'aggancio per tubo 30x20 (A1 - B1 - C1).

The armrest is also available in Siedi e Dormi models.

The version with a fork attaching 30x20 (A1 - B1 - C1) tubes is also available.

Accoudoir prévu aussi pour les modèles Siedi e Dormi.

La version avec fourchette pour attacher les tubes de 30x20 (A1 - B1 - C1) est disponible.

Auch für die Siedi e Dormi Modelle.

Erhältlich in der Ausführung mit Gabel zum Einhängen von 30x20 (A1 - B1 - C1) Röhren.

Brazo disponible también para modelos "Siedi e dormi".

Disponibile versión con horquilla de enganche para tubo de 30x20 (A1 - B1 - C1).

Copertura in legno non fornita.
Wood covering is not available.
La couverture en bois n'est pas disponible.
Keine Holzverkleidung erhältlich.
La cobertura en madera no se suministra.

**BRACCIOLO MOD. B0 30X20****BRACCIOLO MOD. D2 30X20****BRACCIOLO MOD. C0 30X30**

Ø 50

Disponibile versione più alta con fissaggio come bracciolo A2.

Higher armrest available with fixing system similar to mod. A2.

Accoudoirs plus hauts sont disponibles avec un système de fixation similaire au modèle A2.

Harmteil auch in höherer Version verfügbar mit gleicher Befestigung wie Modell A2.

Disponibile versión más alta con fijación como brazo A2.



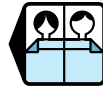

STICK 1 Divano · Sofa · Sessel · Fauteil · Sofá

Versione Letto · Bed · Bett · Lit · Versión Cama

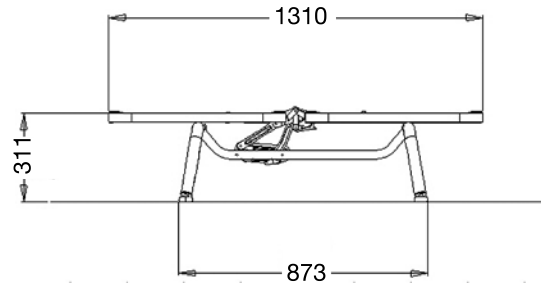
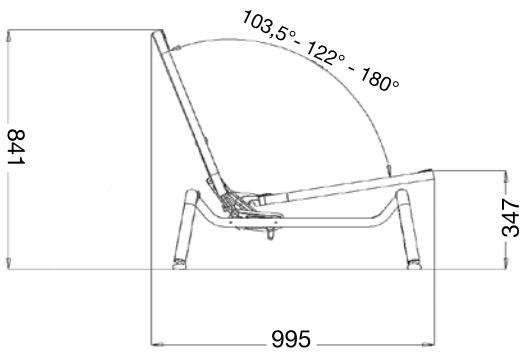

SLIDER Divano · Sofa · Sessel · Fauteil · Sofá

Relax · Stellung zum Entspannen · Versión Relax

Versione Letto · Bed · Bett · Lit · Versión Cama

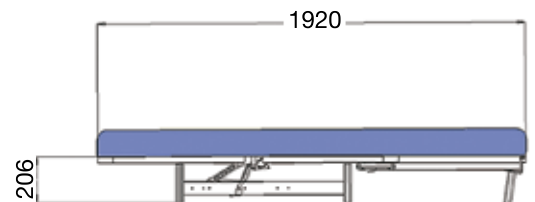
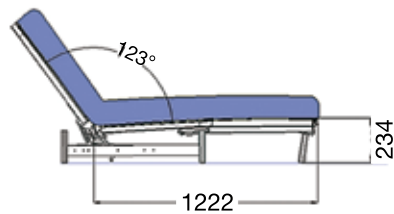
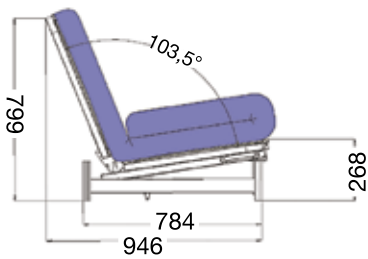

STICK 1 Larghezze · Widths · Larghezza · Largeurs · Anchuras

SLIDER Larghezze · Widths · Larghezza · Largeurs · Anchuras

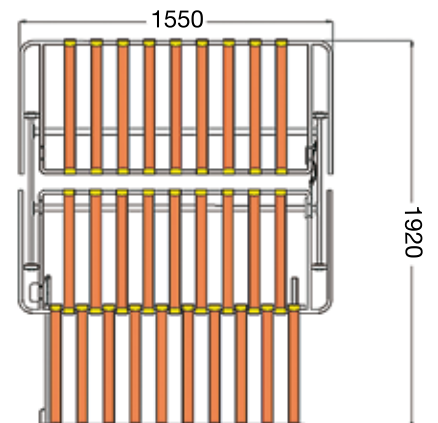
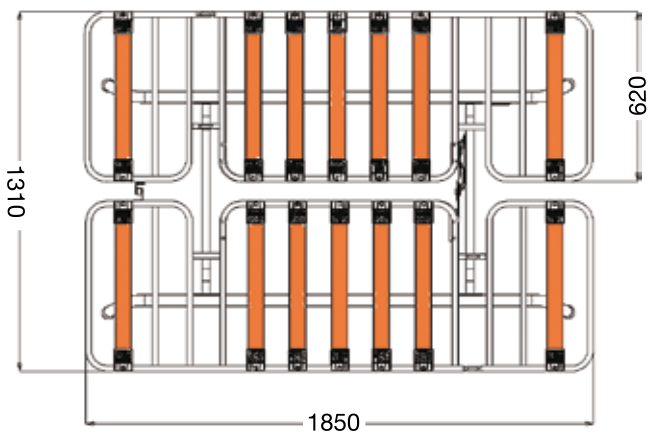

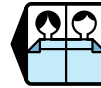

CC E74 Divano • Sofa • Sessel • Fauteuil • Sofá

Relax • Stellung zum Entspannen • Versión Relax

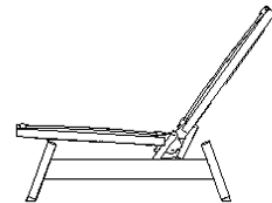
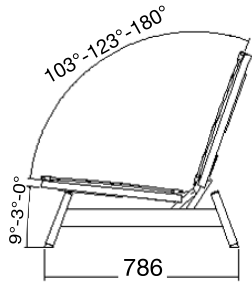

CC E74 Larghezze • Widths • Larghezze • Largeurs • Anchuras

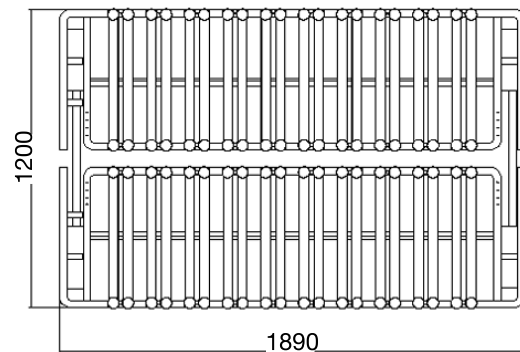
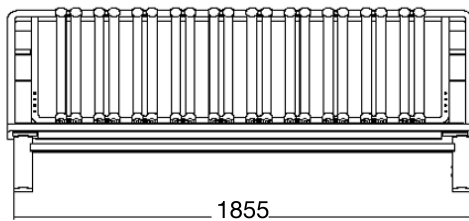

CC R80 Divano • Sofa • Sessel • Fauteuil
Sofá

Versione Letto • Bed • Bett • Lit
Versión Cama

Larghezze • Widths • Larghezze • Largeurs • Anchuras

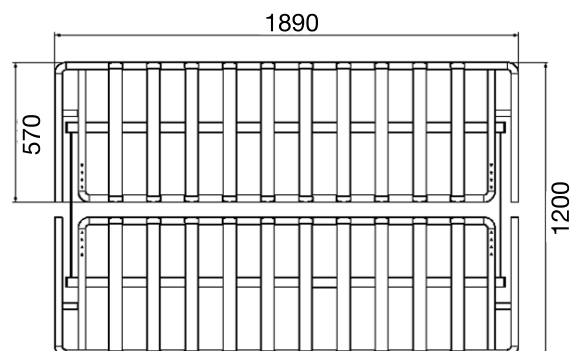
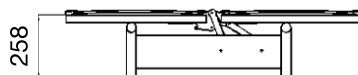
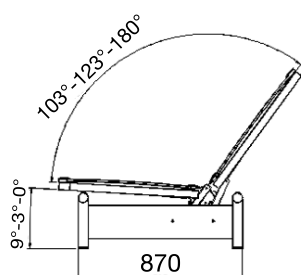

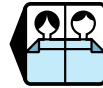

999 Divano · Sofa · Sessel · Fauteil · Sofá

Relax · Stellung zum Entspannen · Versión Relax

Versione Letto · Bed · Bett · Lit · Versión Cama

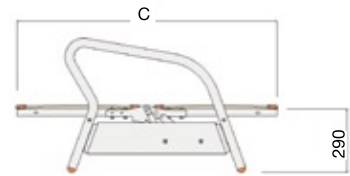
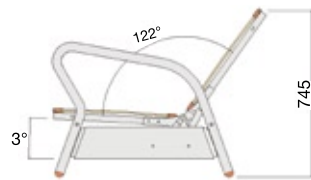
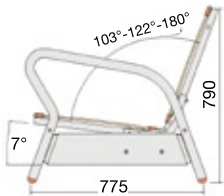

999 / 01 Divano · Sofa · Sessel · Fauteil · Sofá

Relax · Stellung zum Entspannen · Versión Relax

Versione Letto · Bed · Bett · Lit · Versión Cama

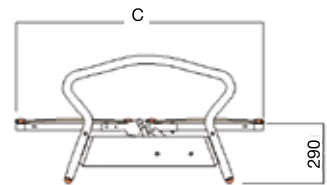
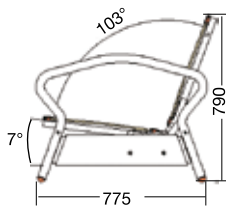

999 Larghezza · Widths · Larghezza · Largeurs · Anchuras

999 / 01 Larghezza · Widths · Larghezza · Largeurs · Anchuras

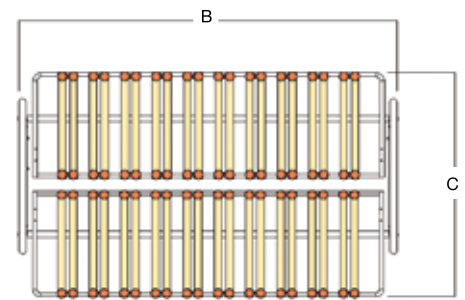
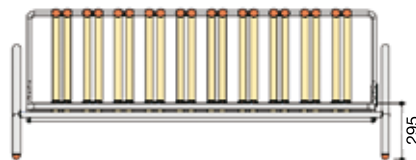
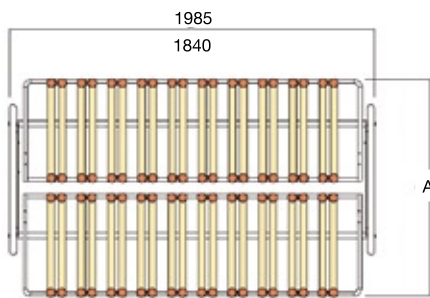



BRIDGE Divano • Sofa • Sessel • Fauteil • Sofá

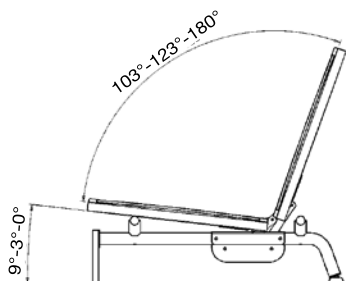

BRIDGE Larghezze • Widths • Larghezze • Largeurs • Anchuras

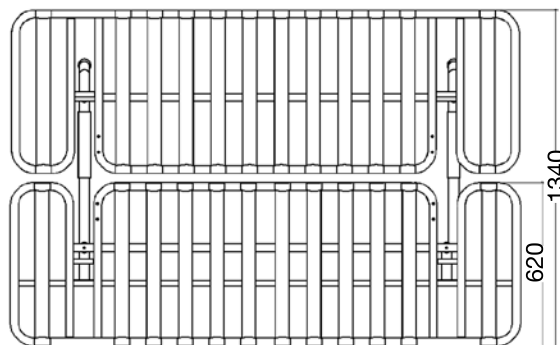
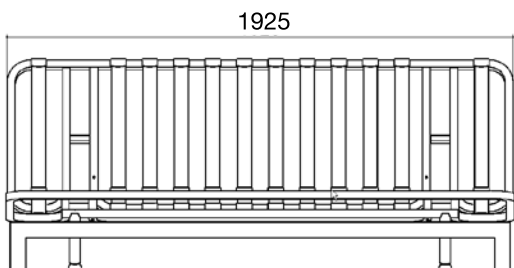

ECLIPSE Divano • Sofa • Sessel • Fauteil • Sofá

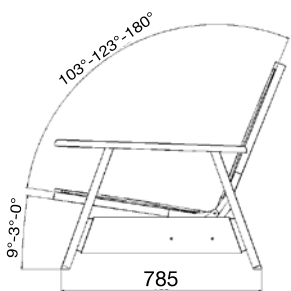

Eclipse 01

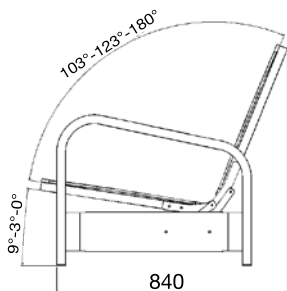

Eclipse 03

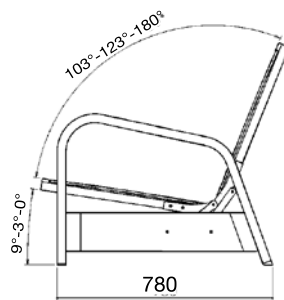

Eclipse 04

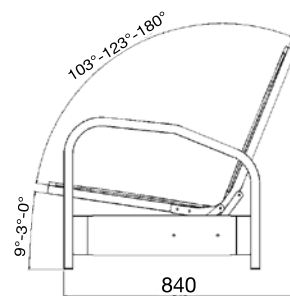

Eclipse 05

ECLIPSE Larghezze • Widths • Larghezze • Largeurs • Anchuras

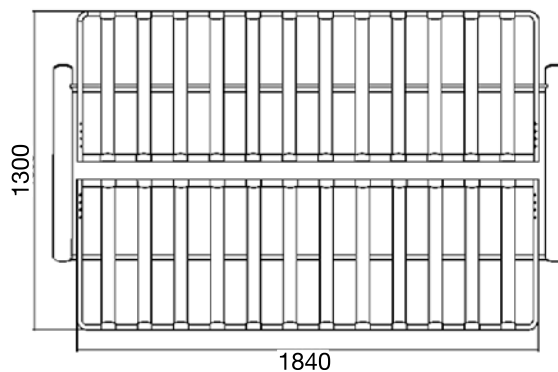
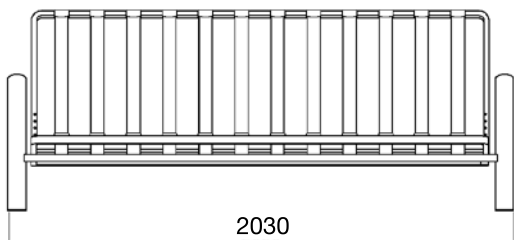

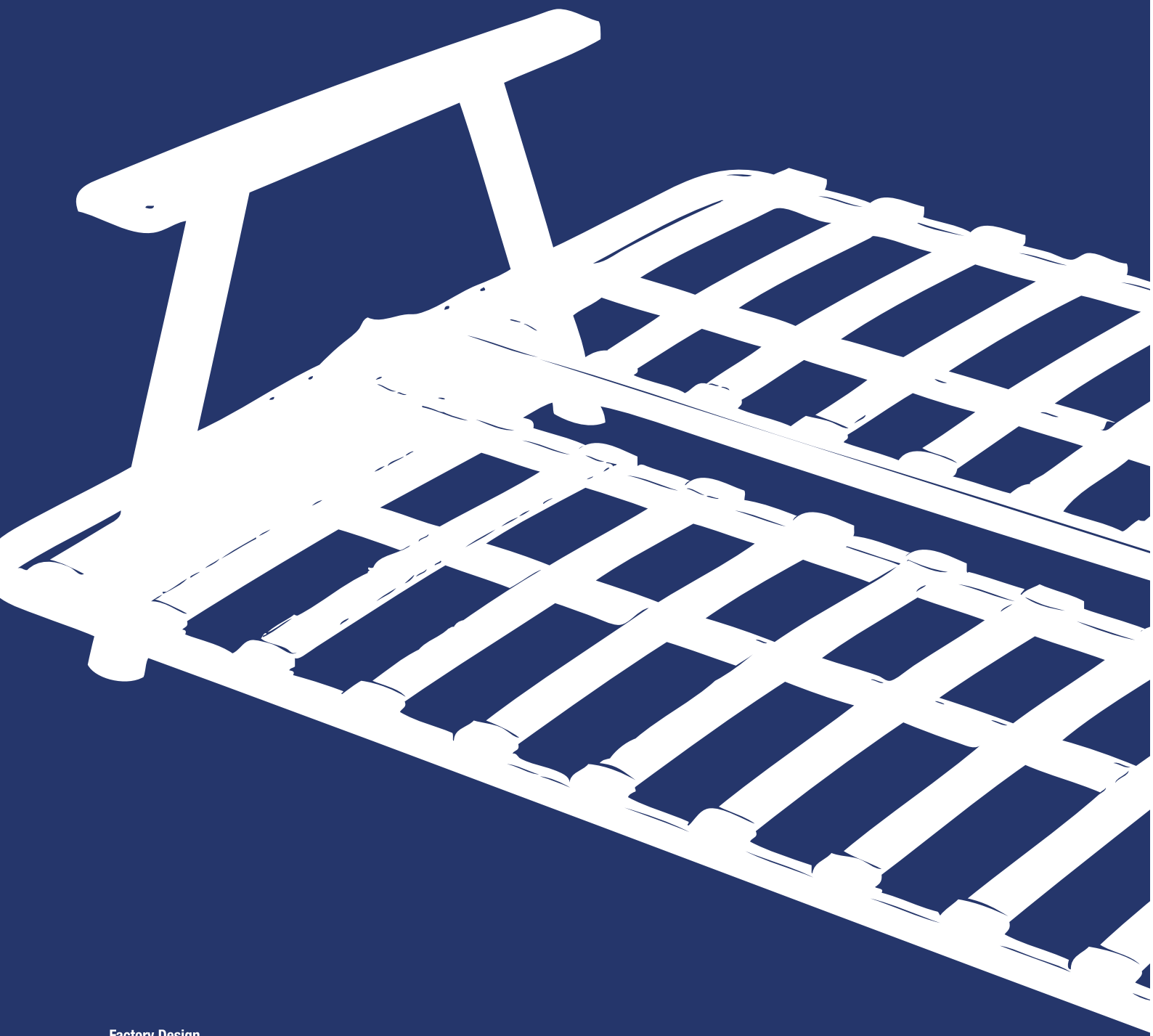

Factory Design



styling
GRUPPO INDUSTRIALE
Azienda certificata ISO 14001

Gruppo Industriale Styling s.r.l.
Stabilimento: Z.I. Jesce
75100 Matera · Italy
Tel. ++ 39 0835 330940/1/3
Fax ++ 39 0835 339138
E.M.: info@styling-industries.com
web: www.styling-industries.com



REG. N. 30202/E
UNI EN ISO 14001-06